

DRAWMER



CONTENTS

Warranty	3
Safety Consideration	3
Radio Frequencies Statement	3
<i>Chapter 1 - Introduction</i>	
Introduction	4
Installation	6
Power Connection	7
Portable Appliance Testing	7
Audio Connection	8
Typical Connection Guide	9
<i>Chapter 2 - Control Description</i>	
Control Description Intro	10
MC2.1 Controls	11
Monitor Calibration	16
Mix Checking Tips	20
<i>Chapter 3 - General Information</i>	
If a fault develops	23
Contacting Drawmer	23
Specification	23
Block Diagram	24

DRAWMER

COPYRIGHT

This manual is copyrighted © 2013 by Drawmer Electronics Ltd. With all rights reserved. Under copyright laws, no part of this publication may be reproduced, transmitted, stored in a retrieval system or translated into any language in any form by any means, mechanical, optical, electronic, recording, or otherwise, without the written permission of Drawmer Electronics Ltd.

ONE YEAR LIMITED WARRANTY

Drawmer Electronics Ltd., warrants the Drawmer **MC2.1 Monitor Controller** to conform substantially to the specifications of this manual for a period of one year from the original date of purchase when used in accordance with the specifications detailed in this manual. In the case of a valid warranty claim, your sole and exclusive remedy and Drawmer's entire liability under any theory of liability will be to, at Drawmer's discretion, repair or replace the product without charge, or, if not possible, to refund the purchase price to you. This warranty is not transferable. It applies only to the original purchaser of the product.

For warranty service please call your local Drawmer dealer. Alternatively call Drawmer Electronics Ltd. at +44 (0)1709 527574. Then ship the defective product, with transportation and insurance charges pre-paid, to Drawmer Electronics Ltd., Coleman Street, Parkgate, Rotherham, S62 6EL UK. Write the RA number in large letters in a prominent position on the shipping box. Enclose your name, address, telephone number, copy of the original sales invoice and a detailed description of the problem. Drawmer will not accept responsibility for loss or damage during transit.

This warranty is void if the product has been damaged by misuse, modification, unauthorised repair or installed with other equipment that proved to be faulty.

THIS WARRANTY IS IN LIEU OF ALL WARRANTIES, WHETHER ORAL OR WRITTEN, EXPRESSED, IMPLIED OR STATUTORY. DRAWMER MAKES NO OTHER WARRANTY EITHER EXPRESS OR IMPLIED, INCLUDING, WITHOUT LIMITATION, ANY IMPLIED WARRANTIES OF MERCHANTABILITY, FITNESS FOR A PARTICULAR PURPOSE, OR NON-INFRINGEMENT. PURCHASER'S SOLE AND EXCLUSIVE REMEDY UNDER THIS WARRANTY SHALL BE REPAIR OR REPLACEMENT AS SPECIFIED HEREIN.

IN NO EVENT WILL DRAWMER ELECTRONICS LTD. BE LIABLE FOR ANY DIRECT, INDIRECT, SPECIAL, INCIDENTAL OR CONSEQUENTIAL DAMAGES RESULTING FROM ANY DEFECT IN THE PRODUCT, INCLUDING LOST PROFITS, DAMAGE TO PROPERTY, AND, TO THE EXTENT PERMITTED BY LAW, DAMAGE FOR PERSONAL INJURY, EVEN IF DRAWMER HAS BEEN ADVISED OF THE POSSIBILITY OF SUCH DAMAGES.

Some states and specific countries do not allow the exclusion of implied warranties or limitations on how long an implied warranty may last, so the above limitations may not apply to you. This warranty gives you specific legal rights. You may have additional rights that vary from state to state, and country to country.

For the USA

FEDERAL COMMUNICATIONS COMMISSION RADIO FREQUENCY INTERFERENCE STATEMENT

This equipment has been tested and found to comply with the limits for a Class B digital device, pursuant to Part 15 of the FCC Rules. These limits are designed to provide reasonable protection against harmful interference in a residential installation. This equipment generates, uses and can radiate radio frequency energy and, if not installed and used in accordance with the instructions, may cause harmful interference to radio communications. However, there is no guarantee that interference will not occur in a particular installation. If this equipment does cause interference to radio or television reception, which can be determined by turning the equipment off on, then the user is encouraged to try to correct the interference by one or more of the following measures:

- Re-orient or relocate the receiving antenna.
- Increase the separation between the equipment and the receiver.
- Connect the equipment into an outlet on a circuit different from that to which the receiver is connected.
- Consult the dealer or an experienced radio/TV technician for help.

Unauthorised changes or modification to this system can void the users' authority to operate this equipment.

This equipment requires shielded interface cables in order to meet FCC class B limit.

For Canada

CLASS B NOTICE

This digital apparatus does not exceed the Class B limits for radio noise emissions set out in the Radio Interference Regulations of the Canadian Department of Communications.

CLASSE B AVIS

Cet appareil numérique ne dépasse pas les limites de la classe B au niveau des émissions de bruits radioélectriques fixés dans le Règlement des signaux parasites par le ministère Canadien des Communications.

SAFETY CONSIDERATIONS

CAUTION - SERVICING

DO NOT OPEN. REFER ALL SERVICING TO QUALIFIED SERVICE PERSONNEL.

WARNING

TO REDUCE RISK OF FIRE/ELECTRIC SHOCK DO NOT EXPOSE THIS EQUIPMENT TO MOISTURE.

WARNING

DO NOT ATTEMPT TO CHANGE OR TAMPER WITH THE SUPPLIED MAINS CABLES.

WARNING

TO REDUCE THE RISK OF FIRE REPLACE THE MAINS FUSES ONLY WITH A FUSE THAT CONFORMS TO IEC127-2. 250 VOLT WORKING, TIME DELAY TYPE AND BODY SIZE OF 20mm x 5mm. THE MAINS INPUT FUSE MUST BE RATED AT T315mA at 115V and T160mA at 315V.

In the interests of product development, Drawmer reserve the right to modify or improve specifications of this product at any time, without prior notice.

MC2.1 Monitor Controller

With the Drawmer MC2.1 Monitor Controller incorporated into your system you combine the clarity, fidelity and transparency of the highest quality monitoring circuit with the complexity of a host of mix checking features. It is versatile and intuitive, but above everything else, where the Drawmer MC2.1 excels is in its accuracy and ability to faithfully reproduce what has been recorded.



The MC2.1 incorporates four inputs with three stereo balanced speaker outputs, plus a dedicated mono speaker/sub-woofer output each with individual left/right trims under the unit to provide complete control over level matching. The active circuit has been designed to faithfully produce the audio signal whilst removing many of the problems that a passive circuit will bring. In addition, it has a host of mix checking features not often found on other controllers, such as individual left/right cut, as well as two separate headphone amplifiers and a talkback facility, making the MC2.1 a true engineers tool.

Drawmer MC2.1 Monitor Controller Features at a Glance:

- Ultra low noise and transparent circuit design. Linear power supply with low hum toroidal transformer and internal voltage selector switch.
- 3 stereo balanced speaker outputs, plus a dedicated mono speaker/sub-woofer output. All have individual left & right trims under the unit to provide complete control over level matching.
- Timed relay protection on all speaker outputs to prevent power up/down bangs.
- Comprehensive mix checking facilities including Left/Right Cut, Phase Reverse, Mono, Dim, Mute.
- Paralleled custom quad pots on main and headphone level controls for excellent channel matching and smooth feel.
- Four inputs including balanced Neutrik XLR, balanced Neutrik XLR/JACK COMBI, and shared aux phono or 3.5mm jack.
- Two headphone amplifiers with individual level controls.
- Built in talk back microphone with level control, mono output jack and internal headphone routing.
- Rugged steel chassis and stylish black brushed aluminium cover. Can be stacked and is rack mountable (using a 2U mounting kit).
- Dimensions: L 272mm x W 215mm x H 81mm. Weight: 2.5kg.

Whether you're mastering a cd/dvd, recording, checking a mix for balance and e.q, doing A/B comparisons, plus a multitude of other tasks, you'll have spent weeks designing the perfect studio environment and a fortune on active speakers, dynamics processors, various microphone and preamplifier combinations as well as a whole room full other gear, one thing is for sure - a monitor controller is central to every recording setup and probably the most important element of the entire signal chain - providing the 'reference' listening signal that enables the user to achieve the optimal mic placements, the perfect balance and EQ etc. There is one thing that should always be absolutely guaranteed - that you can rely on the accuracy of your monitor controller.

It is imperative that what you've recorded is exactly what you hear - this is the philosophy that is at the heart of the design of the MC2.1. A monitor controller should certainly not degrade the quality of a recording in any way, but it should not artificially improve it either, otherwise how are you supposed to trust anything that you're recording. You may have come across the term WYSIWYG as used in web design - 'what you see is what you get' - we would like to think that the MC2.1 is the audio equivalent to this term - 'What You Record Is What You Get'.

Active vs. Passive Circuits

There is a great debate as to which is best - a passive or active monitor control circuit. The theory is that passive monitor controllers must be best, since they do not add transformers or other components to the signal path, along with the noise and distortion that they can bring, however they have severe disadvantages over active circuits. The most significant is that the output impedance of the connected source equipment and the input impedance of the power amp or active speaker will affect the workings of the passive controller - each needs buffering to remain reliable and consistent, otherwise level matching problems will be inevitable. Since even the best cables have capacitance, it is extremely important to keep cable lengths to an absolute minimum (i.e. less than a couple of meters) to avoid signal degradation especially in high frequency signals. Long cables will act like a simple low frequency filter.

Furthermore, it is incredibly difficult to get a mono signal from a passive circuit without affecting the sound so any kind of reliable mix checking becomes near impossible.

Active designs make it easier and more reliable to guarantee a high performance level as the signal attenuation and switching is actively buffered, as well as providing complete control over distortions, crosstalk, frequency response, and transient fidelity. Moreover, cable lengths of tens of meters should not be an issue. Furthermore, it makes it possible to introduce mix checking features that would otherwise be missing. The disadvantage with active monitor controllers is that the electronics have the potential to introduce noise and distortion. Designing a clean monitor control system is far from simple, however, using only the very best components and clever circuit design, with the Drawmer MC2.1 we have overcome all of these problems and managed to combine the best of both - whilst retaining the transparency and responsiveness that a passive circuit would bring with the advantages of an active one.

INSTALLATION

The MC2.1 is a free standing, desktop unit, with controls and headphone jacks on the front panel and all other inputs and outputs on the rear. Multiple units can be stacked whilst sitting on the desk, however, the MC2.1 can be screwed to the desk or into a standard 19" rack (using a 2U mounting kit).

Note that whether fixing to a desk or to a rack the speaker trims on the base of the unit will not be accessible and so the calibration procedure should be carried out before fastening the MC2.1 in place (see 'Monitor Calibration').

Screwing the MC2.1 to a desk.

Rather than having the MC2.1 free standing it can be fastened down to a desk by utilising the holes that hold the rubber feet to the underside.

Drill four holes into the desk, at 4mm in diameter and to the dimensions as shown in the diagram. (Note that the diagram is viewed from above).

Pushing four screws through the under-side of the desk screw the MC2.1, including the rubber feet, to the panel to secure. The screws should be M3 and have a length of 14mm plus the thickness of the panel.

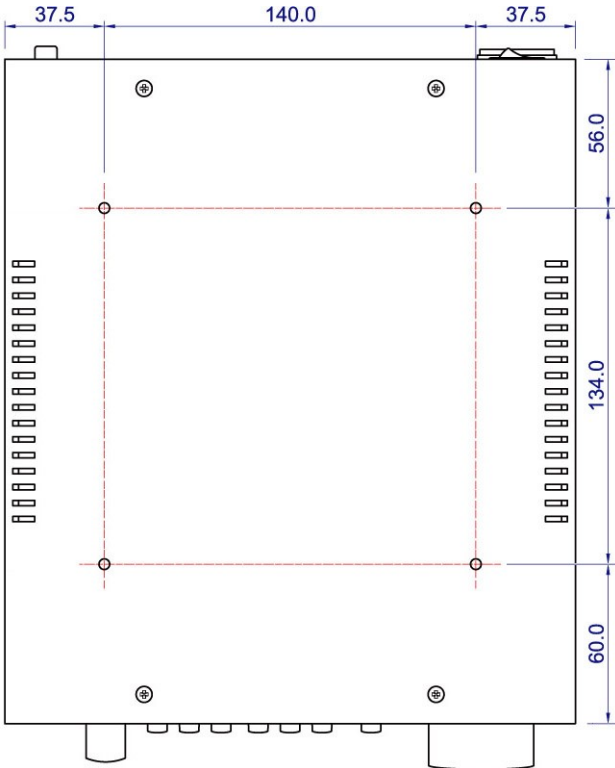

POWER CONNECTION

The MC2.1 unit will be supplied with a power cable suitable for domestic power outlets in your country. For your own safety, it is important that you use this cable to connect to the mains supply earth. The cable must not be tampered with or modified.

The power supply socket has an integral fuse drawer containing the power fuse of the same value, to suit the mains voltage for which the unit has been supplied. Removal of the drawer is only possible with the power cord removed. The fuse should never blow under normal operation. If the fuse is suspected of having blown, then a fault will have occurred and this fault condition should be inspected by a qualified service engineer. When replacing the fuse, always comply with the Safety Instructions.

If the unit is to be used with a mains input operating voltage different to that for which the unit is supplied, the following procedure must be carried out by a technically competent person:

- 1: Disconnect the unit from the mains.
- 2: Using a number 1 size pozidrive screwdriver, remove the eight screws that retain the top cover. Two screws are found along each side and four on the top.
- 3: With the cover removed slide the voltage change-over switch (**S14**) until the correct (or nearest) mains input voltage is visible on the switch actuator. The switch is located to the top right of the main circuit board between the mains I.E.C. and toroidal transformer.

For conversion to 115Volt AC (previously set to 230Volt AC).....

4a: Exchange the 160mA fuse below the mains socket for a similar type rated at 315mA

For conversion to 230Volt AC (previously set to 115Volt AC).....

4b: Exchange the 315mA fuse below the mains socket for a similar type rated at 160mA

In all cases:

- 5: Replace the top cover using the eight screws.
- 6: Re-connect to mains power source.



PORTABLE APPLIANCE TESTING

To undergo a Portable Appliance Testing procedure (commonly known as "PAT", "PAT Inspection" or "PAT Testing") use any one of the screws that hold the feet to the bottom of the unit. These screws connect directly to the chassis and provide the earthing point. If required, the foot can be removed and the cavity probed, or the screw can be replaced for something more suited to the job, such as a spade terminal with a M3 thread.

AUDIO CONNECTIONS

XLR - OUTPUT (MALE)

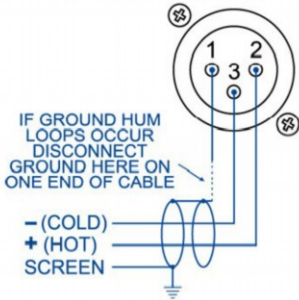

XLR - INPUT (FEMALE)

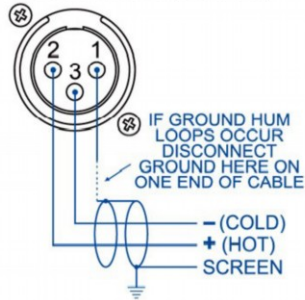

1/4" JACK - BALANCED MONO

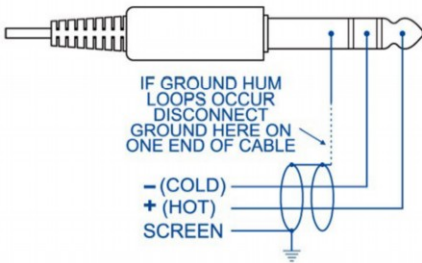

1/4" TALK BACK JACK - UNBALANCED MONO

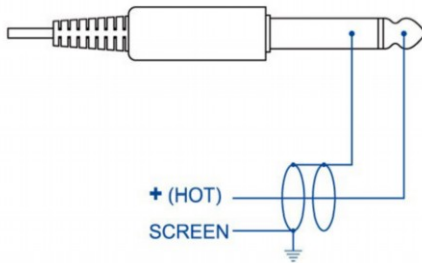

RCA (PHONO) JACK

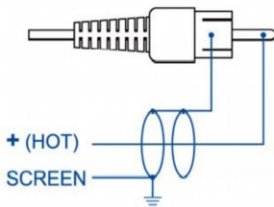

3.5mm HEADPHONE JACK

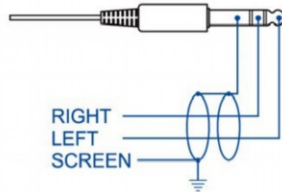

- **Interference:**
If the unit is to be used where it may be exposed to high levels of disturbance such as found close to a TV or radio transmitter, we advise that the unit is operated in a balanced configuration. The screens of the signal cables should be connected to the chassis connection on the XLR connector as opposed to connecting to pin 1. The MC2.1 conforms to the EMC standards.
- **Ground Loops:**
If ground loop problems are encountered, never disconnect the mains earth, but instead, try disconnecting the signal screen on one end of each of the cables connecting the outputs of the MC2.1 to the patchbay. If such measures are necessary, balanced operation is recommended.

TYPICAL CONNECTION GUIDE

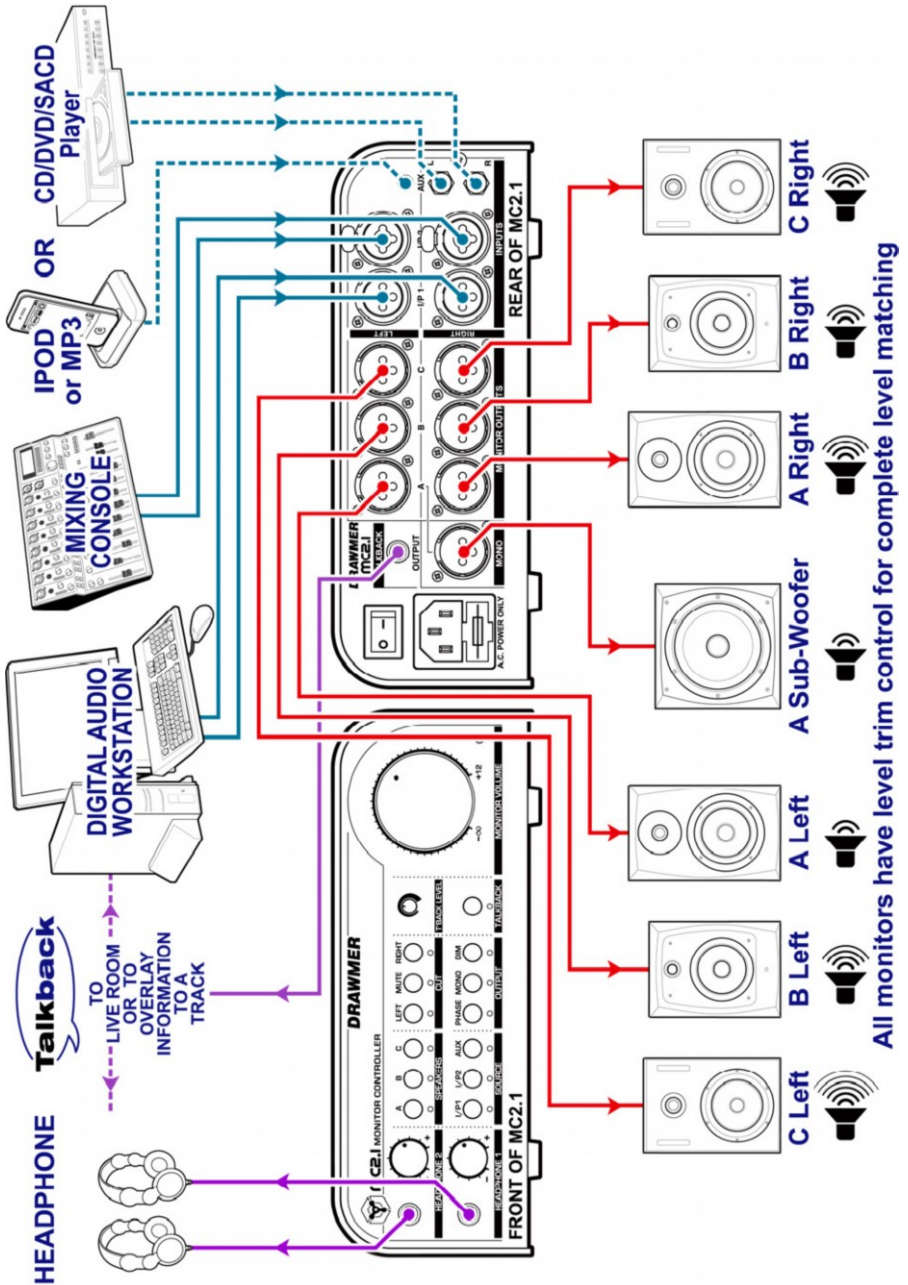

CONTROL DESCRIPTION

As well as a transparent and precise signal path the MC2.1 Monitor Controller incorporates many impressive features which are invaluable to the sound engineer when listening to and examining the quality of the audio:

Three stereo balanced speaker outputs, plus mono speaker/sub-woofer output with individual level control for level matching.

Comprehensive mix checking facilities.

Four simultaneously selectable inputs.

Two headphone amplifiers with individual level controls.

Built in talkback microphone with level control, mono output jack and internal headphone routing.



The MC2.1 Controls

1 SOURCE

Three switches select which of **I/P1**, **I/P2** and **AUX** is heard (see 8). Each can be operated individually or simultaneously and in any combination. When operated simultaneously the individual signals are summed into a single stereo signal. Note that the MC2.1 does not provide individual level trims for the inputs and so any level matching should be applied before it reaches the MC2.1.

2 SPEAKERS

Three switches select which of the three speaker outputs **A (plus additional mono output)**, **B** or **C** are heard (see 9).

Each switch can be operated individually or simultaneously and in any combination and is perfect for performing A/B comparisons between various monitor setups. As the switches do not toggle between outputs when doing A/B comparisons both of those switches should be pressed at the same time i.e. to compare speakers A and C, with A active press both the A and C switches to swap the output to C active, and then again to return to the previous setting - this method can be used between all three outputs if required.

An additional benefit is derived when using a sub-bass. If the sub-bass is attached to output A, delivering the lower frequencies, outputs B and C could deliver the higher frequencies and allow for A/B (or in this case B+Sub/C+Sub) comparisons between the two monitor setups by pressing the B and C switches simultaneously and leaving A always active.

Note that each speaker output has individual level trimming on the base of the unit so that precise monitor level matching can be achieved - see sections 9 & 12 and also the 'Monitor Calibration' section.

3 MIX CHECKING

The mix checking section comes under two headings, **Cut** and **Output**, and when used in conjunction with each other is a very thorough and versatile checking tool. Under the Output heading three switches have been incorporated providing **Phase Reverse**, **Mono** and **Dim**.

Phase Reverse: Inverts the polarity of the signal on the Left Channel and is used primarily to outline any phase problems that may be occurring in the mix/recording such as phase cancellation, or an unbalanced stereo signal. As the switch is toggled any phase issues will become more apparent and easier to identify.

Mono: With the switch active both Left and Right stereo signals are combined into a single mono signal.

It is necessary when testing the audio to not only listen to the signal in stereo but also in mono. It helps to outline problems in the mix, but also when testing for use on non-standard applications such as for broadcast or mobile phone.

Dim: With the switch active the output level is attenuated by 20dB's. It enables you to lower the volume without adjusting any of the settings.

DRAWMER

Mix Checking cont....

Under the **Cut** heading three switches have been incorporated - **Left Cut**, **Mute** and **Right Cut**.

Left Cut: Mutes the Left channel signal allowing only the right signal to be heard,

Right Cut: Mutes the Right channel signal allowing only the left signal to be heard,

Mute: Cuts both channels (especially useful in an emergency). If Left Cut and Right Cut are both active it is just the same as Mute being active.

Note that **Cut/Mute** does not affect the headphones (see ④) in the same way as it does the speakers (see ⑨). With the **Mute** switch active the headphones will still pass audio in just the same way as if it was off, they are not affected. This allows for someone to edit audio using headphones whilst a conversation is occurring in the control room, for example.

Also, note that, when activating **Left** or **Right Cut** whilst using headphones the signal is not 100% panned one way or the other - i.e. the signal centre moves to the side but is not completely removed from the opposite ear of the headphone - this is so that the **Left/Right Cut** sounds a little more natural, after all, if listening through speakers with only the left speaker active some of the signal will reach the right ear a few milliseconds later.

④ HEADPHONES

The MC2.1 has two dedicated headphone outputs, via 1/4" TRS jacks, each with individual level control - Note that they have their own level control and are not affected by the main large monitor volume knob.

In addition, note that the headphones are not always affected by the switches in the same way as the monitor outputs. The **Source** Controls (**I/P1**, **I/P2** and **Aux.**) and **Output** controls (**Phase Rev**, **Mono** and **Dim**) affect the headphones in just the same way as the speakers, however, the **Mute** and **L/R Cut** switches affect them differently (see above).

Warning:

It is advisable to unplug the headphones before switching the MC2.1 on or off. It is also recommended that you turn the headphone level down before inserting the jack, and turn it up to your desired listening level - these measures will not only prevent your ears from being damaged but also the headphone's drivers. Also, note that these are high quality circuits and have been designed for professional headphones, so care must be taken when using lower standard, consumer quality headphones, such as earbuds or ipod phones etc, as damage could occur.

⑤ TALKBACK

The MC2.1 has a dedicated talkback function including inbuilt microphone and gain level control.

Talkback Switch: When active engages the inbuilt microphone and routes the operator's voice through the headphones and also to the output on the rear of the unit. The switch is non-latching and so must be held in to be active.

Talkback Level. The knob adjusts the gain level of the talkback microphone. It can be adjusted to compensate for the distance that the operator is from the microphone, how loud his voice is, or the volume of the underlying music played, as well as several other factors.

TalkBack Microphone. An electret condenser microphone has been incorporated into the MC2.1 and is located above the Talkback Level on the front panel.

Activating the Talkback automatically engages the Dim switch (i.e. attenuates the volume by 20dB) for the headphones **4** and also the speaker outputs **9** making it possible for the artist to clearly hear the instruction.

As well as the headphones the talkback signal is also routed to the direct talkback output jack on the rear of the unit **10** to be routed at the engineers discretion.

To operate talkback press the talkback switch and then turn the gain level up until all those wishing to hear the operator's voice can. Talkback is only active whilst the switch is held in and will de-activate once the finger is removed.

6 MONITOR VOLUME

The Monitor Volume control adjusts the signal level of both stereo channels for all speaker outputs. The Volume knob affects the volume of the monitors A (plus the mono), B, & C only and does not have a bearing on any other output such as the headphones or talkback jack.

Because the circuitry is active it allows for the signal level to be increased, rather than only attenuated, making subtle problems within the mix (such as noise at low levels, or unwanted harmonics, for example) more obvious and easier to iron out, especially during musical passages that would normally be quiet.

The volume knob circuit design incorporates a paralleled custom quad potentiometer, for excellent channel matching and a smooth feel, with a range from Off (-infinity) to +12dB of gain.

Before you can make full effective use of the Volume control it is necessary to calibrate the entire monitoring system (see the 'Monitor Calibration' section) - this allows for accurate level control, as well as left/right balance throughout the knob's range. Note that the actual output levels, including the maximum output level and the position of unity gain (0dB) around the knob, will alter depending on the calibration of the monitors.

WARNING:

It is recommended that you turn the volume control down to a lower level before turning the MC2.1 off - this is to ensure that a sudden volume increase when turning on does not damage your speakers or your hearing

In addition, do not use excessive force at either end of the volume knob - it's size would mean that damaging the potentiometer is possible.

7 POWER LED

A lit 2mm LED indicates that the unit is switched on. To turn the MC2.1 on see the mains input section **11**.

DRAWMER

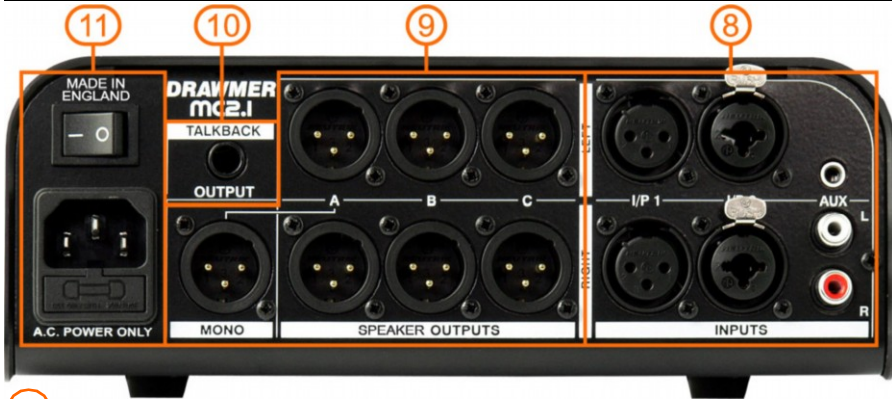

8 INPUTS

The MC2.1 has four inputs comprising a **I/P1** - a balanced Neutrik XLR, **I/P2** - a balanced Neutrik XLR/jack combi (combining a 3 pole XLR receptacle and ¼" phone jack in one XLR housing), and also **AUX** - a shared input comprising of stereo RCAs and a 3.5mm stereo jack.

Each input is activated by the **Source** switches (see 1)

Note that **AUX** is a shared input and if both inputs are used simultaneously the signal will be summed into one stereo signal, however level matching will need to be controlled prior to the MC2.1.

9 OUTPUTS

Three stereo balanced speaker outputs- **A**, **B** and **C**, plus a dedicated mono speaker/sub-woofer output - **MONO** - are found on the rear of the unit, all in the form of Neutrik 3 pin XLRs. Each of these outputs has an individual Left/Right/Mono trim potentiometer on the underside of the unit to enable easy and accurate monitor level/room matching throughout (see 'Monitor Calibration').

Each output is activated by the **Speakers** switches (see 2) - and can be activated individually or simultaneously and in any configuration.

10 TALKBACK

A dedicated ¼" mono talkback output jack can be found on the rear panel, so that, as well as being routed through the headphones, a talkback signal can be routed to other devices at the engineers discretion. This could usually be patched into the live-room active monitor speakers for convenience when recording acoustic ensembles where the performers may not wish or need to wear headphones. It could also be used as an added channel on a mixing desk to be patched into a multiple headphone amplifier along with the stereo mix, for example. The jack also allows for routing into a separate channel of a DAW, or other recording facility, to allow for information overdubs to be added to a recording.

To connect the mono talkback to a Dual Mono jack use the following cable wiring:

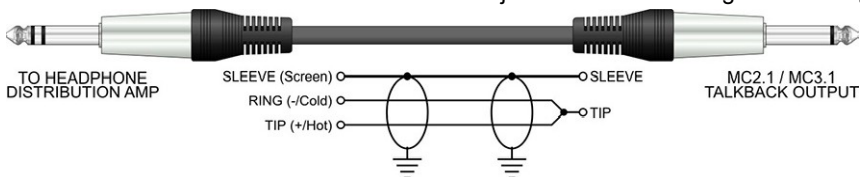

11 MAINS I.E.C. AND POWER SWITCH

The mains inlet, I.E.C., which also incorporates the internal mains fuse, can be found on the rear of the unit. A mains lead will have been provided with the MC2.1 to suit the mains configuration for the country of your purchase.

The power switch is located above the I.E.C. and is used to switch the unit on and off. This is a hard boot switch (as opposed to a soft stand-by switch) and so when in the off position the MC2.1 will draw no mains power.

Note that a timed relay protection circuit has been incorporated into the MC2.1 to prevent bangs and other potentially harmful artifacts from occurring during power up and power down.

12 SPEAKER CALIBRATION TRIM CONTROLS

On the under-side of the MC2.1 there are seven rotary controls that allow the individual speaker level calibration of your system. Each speaker output has a control, including the mono/sub. To alter the speaker level use a small screwdriver to turn - counter-clockwise turns the speaker level down, and clockwise up.

For the calibration process see the “Monitor Calibration” section of this manual. Once the system has been calibrated these trims should not be touched.

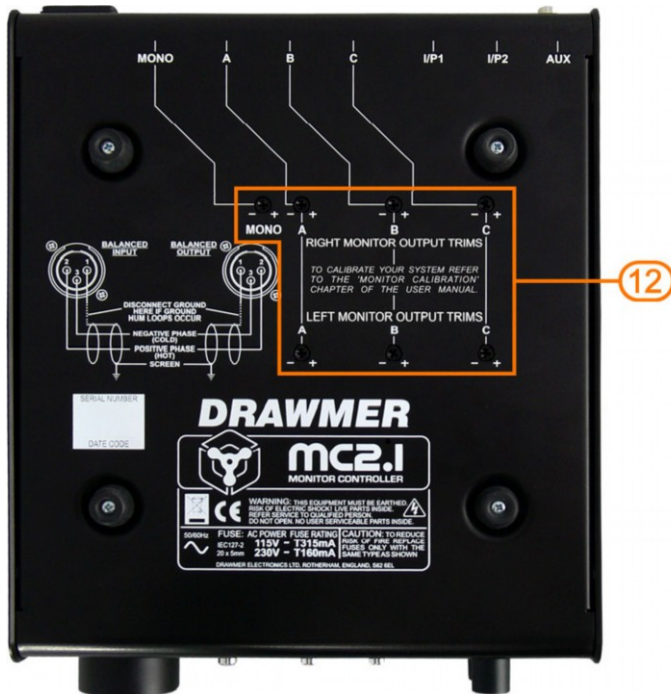

MONITOR CALIBRATION

Whether you are installing one, two or three sets of speakers it is imperative that your system is calibrated, not only to centre the stereo image and to ensure that all speaker levels are the same, but also to ensure that you are mixing your music at industry standard listening levels. The MC2.1 can calibrate the speakers of any system as it has individual rotary level trim controls for every speaker attached (found on the under-side of the product).

The following method is by no means the only way to calibrate your system, and a quick look on the internet will soon find many others, but is a good starting point.

Before beginning the procedure there are a couple of things that you will require:

Sound Pressure Level (SPL) Meter:

Unfortunately, it is virtually impossible to measure the level of sound from each speaker by ears alone. A good instrument that does a more accurate job is a Sound Pressure Level meter.

SPL Meters come in two varieties: with an analog meter or with a digital display, either works well, just choose your preferred type. You can purchase an SPL meter from most electronic stores, or search the internet in stores such as Amazon, with prices ranging from £25 to £800. Radio Shack is a good source for reasonably priced SPL meters in the USA, though to get better results, you may consider a more expensive SPL meter, such as Galaxy, Gold Line, Nady, etc.

The ideal meter should have the industry standard “C-weighted” curve, slow setting. Refer to your meter’s manual to learn how to select these settings.

If all else fails there are iPhone/Android apps that claim to be SPL meters - whilst these are no-where near the quality of a dedicated meter they are better than nothing.



Test files:

Test tones can either be generated through your DAW (such as the Signal Generator plug-in in Pro Tools), but you can also download test/calibration files from the internet if you search around: wav files are preferred to mp3's due to the compression/limited frequency range of mp3's. You can also purchase good quality reference CD's/DVD's from various stores.

The tones required for this calibration process are:

1. 40Hz to 80Hz bandwidth limited pink-noise file recorded at -20dBFS.
2. 500Hz to 2500Hz bandwidth limited pink-noise file recorded at -20dBFS.
3. Full-bandwidth pink-noise file recorded at -20dBFS.

Holding the SPL - Set the meter to C weighted and on the slow scale. Start by sitting in your normal mixing position, hold the SPL meter at arm's length and at chest level with the microphone of the meter facing toward the monitor to be calibrated. Maintain this position throughout the calibration process - this could be easier if it is fixed via a stand and bracket, and moved only to point at the relevant speaker.

The following method sets the sound pressure level to 85dB - the standard listening level for film, tv and music, however, due to the sound being altered by the size of the room, this can alter, essentially, the smaller your room is, the lower your listening level should be, down to around 76dB. The following table should give an idea of the sound pressure level to use for your environment.

Room Size		SPL Reading
Cubic Feet	Cubic Metres	
>20,000	>566	85dB
10,000 to 19,999	283 to 565	82dB
5,000 to 9,999	142 to 282	80dB
1,500 to 4,999	42 to 141	78dB
<1,499	<41	76dB

Listening at appropriate levels for your specific environment will help maintain the integrity of your mixes as they move from one system to another, in rooms of varying sizes.

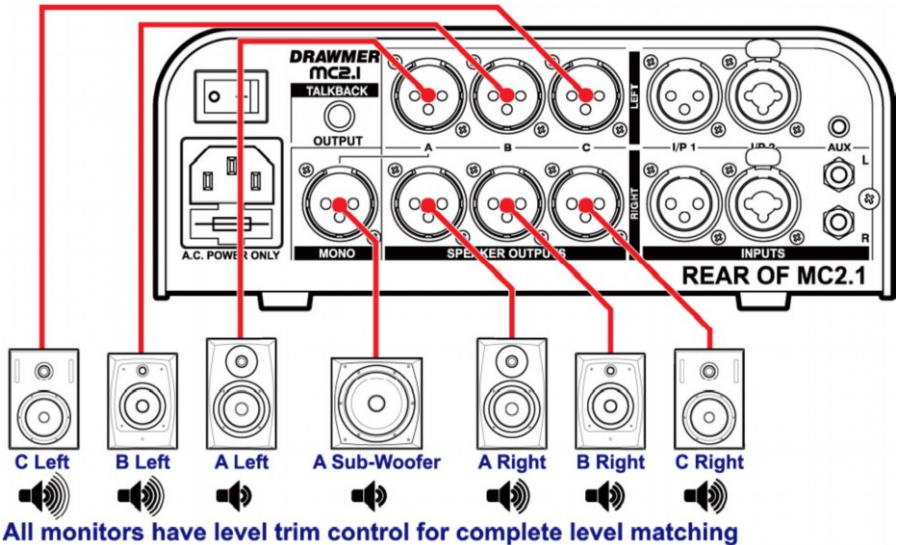

DRAWMER

The Procedure:

1. Begin by turning off the monitoring system and ensuring that all inputs and speakers are correctly connected.
2. Set all DAW/System controls to 0dB/unity gain - this should be left at this setting from now on. Remove all e.q. and dynamics from the signal path.
3. If you have active speakers with their own level control, or speakers with an amplifier, set all of these to maximum, so that they do not attenuate the signal.
4. On the underside of the MC2.1 you will find the speaker calibration trims - using a screwdriver initially set all of them to their full attenuation position by rotating each fully counter-clockwise. (See photo, opposite page).
5. Set the large volume on the front of the MC2.1 to 12 O'clock and leave it there throughout the calibration procedure - this will be the position that provides the 85dB listening level from now on.
6. Turn the system on and play the 500 Hz – 2.5 kHz bandwidth-limited pink noise at -20 dBFS. Select the required Source on the front of the MC2.1 - I/P1, I/P2 or AUX. You should not hear it yet.



7. Activate the A Speaker by having only the Speaker A switch active in the speakers section on the front panel.
8. In order to hear only the Left A speaker remove the right speaker by activating the Right Cut switch.
9. On the underside of the MC2.1 rotate the Left A trim clock-wise. You will now start to hear the signal, but only for that speaker. Rotate until the SPL meter reads 85dB.
10. In order to hear only the Right A speaker switch in Left Cut and deactivate the Right Cut.

11. On the underside of the MC2.1 rotate the Right A trim clock-wise until the SPL meter reads the desired level.

12. To calibrate each speaker repeat steps 7 to 11 - replacing the speaker on step 7 for each set - A,B or C.

13. To calibrate the sub - play the 40-80Hz signal, but this time have only Speaker A active -ensure that other speakers are off.

14. On the underside of the MC2.1 increase the Mono trim increasing the volume of the sub until the desired SPL meter reading is reached.

15. Repeat steps 7 to 12 whilst playing the full bandwidth pink noise and adjusting to suit. The readings should be pretty close and only require fine adjustment.

16. You are finished and the calibration process has been completed.

The volume control will have a few dB's of headroom so care must be taken to both your hearing and system when increasing the volume past the 12 o'clock position.

As with all things that are calibrated it's a good idea to regularly check the calibration of your monitors to ensure that nothing has changed.

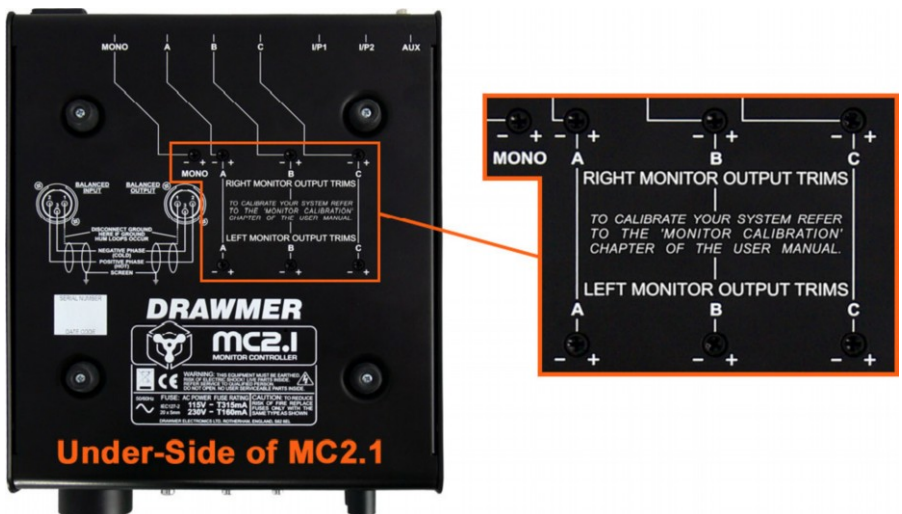

Mix Checking Tips

Due to the versatility of the MC2.1, and its thorough array of controls, some very useful techniques for checking your mix can easily be achieved, that can help improve the balance within a mix, pinpoint stereo width, phase and mono problems, and also aid when monogising.

The following are a few handy tips to help eradicate problems and bring about a balance within the mix:

Not too loud...

Give your ears a break. Do not have the volume too loud - frequent monitoring at anything above 90dB will only make your ears tired, meaning that you won't really hear the problems that may be occurring, and give you a false sense that the mix sounds nice and loud. Also, constant listening at anything above 100dB will probably have a long term detrimental effect on your hearing.

Shhhh...

Get into a habit of listening to your mix at very low levels quite often. Remember that not everyone listening to your song has music blasting out. As well as giving your ears a break, it will heighten problems in the mix - Do the key elements have a good balance, or are some instruments more prominent than they should be? If something is too quiet or loud adjust its volume or use E.Q. to fix it. If the mix sounds good at low levels it's likely that it will when loud.

Note that on the MC2.1 it is better to lower the volume level using the DIM switch and then turn the volume up, rather than only turning the volume down, as you maintain greater control over the volume as well as better left/right channel matching.

Increase the Volume of Quiet Passages.

Because the MC2.1 circuitry is active it allows for the signal level to be increased, rather than only attenuated, making subtle problems within the mix, such as noise at low levels, or unwanted harmonics, more obvious and easier to iron out, especially during passages that would normally be quiet.

Here, There and Everywhere.....

Listen to your mix on as many systems as possible. The three monitor outputs allows for the addition of a non standard testing setup i.e. the system could be forced to emulate low-quality domestic reproduction systems as well as car speakers or a portable radio, by incorporating limited-bandwidth speakers to output C. In such conditions you may find that an instrument drops out of the mix, or another is too prominent, and adjustment to the mix need to be made. For best results calibrate the speakers to match the output level of the rest of the system.

Cut It Out...

Using the left and right cut switches will highlight the stereo balance of each channel. In stereo the mix sounds ok, however, it may be that you want an instrument to be panned so far left that it doesn't occur at all in the right channel, by cutting the left and only hearing the right channel you will hear whether the instrument bleeds across, and panning adjustment can be made.

Phase Reverse...

Make use of the phase reverse switch. If the sound doesn't become less focussed when the polarity is flipped then there is something wrong somewhere. Not only will the switch help confirm that the monitor speakers are wired up in the correct polarity, phase inversion on a particular instrument can at times improve the way the instrument interacts with the rest of the mix by removing the phase cancellation.

Monogising

Check your mix in mono - often! Just because a mix sounds good in stereo doesn't mean it will sound good when the left and right channels are combined. Why should you care if your mix sounds good in mono? Well, most live music venues and dance club sound systems are mono - running the PA or sound system in mono is common practice to ensure music sounds good everywhere in the room because it removes the 'sweet spot' and the complex phase issues of stereo. In many cases the low frequencies will be put through a crossover and summed to mono before being sent to the sub, such as in a home theatre system, for example. Monogising is also necessary when testing the audio for use on non-standard applications such as for broadcast or mobile phone.

In addition, monogising will highlight phase problems. In some cases, when you activate the Mono switch you may hear comb-filtering, which will colour the sound of your mix and cause peaks and dips in its frequency response. When a stereo mix is combined into mono any elements that are out of phase will drop in level or may even disappear completely. This could be because left and right outputs are wired out of phase but its more likely to be due to phase cancellation.

What causes phase cancellation?

Many stereo widening effects and techniques, such as chorus;

Simultaneous direct box and mic recording - If you've ever recorded a guitar simultaneously through a direct box and a microphone, you may have noticed the time alignment problems this causes. This type of situation can often be fixed by careful mic placement, or realigning the waveform in a DAW;

Any situation where more than one microphone is used to record a source - on a multi-miked drumkit two mics may pick up exactly the same signal and cancel each other out. It may sound unlikely but one handy tip is to adjust the panning of your drums whilst in mono - suddenly all the phase cancellation of the drums will improve, and sound even better when reverted back to stereo.

DRAWMER

Listening in mono also highlights problems with the stereo width and balance of the mix and is more apparent when you use a lot of stereo-widening or width-enhancing techniques and tools. Switching mono in and out fairly quickly may make it apparent that the centre of the mix is shifting to the left or right, something that may go unnoticed if only working in stereo.

True Mono

As a mono signal would normally originate from a single source it would be wrong to simply activate the mono switch - as both left and right speakers are still active. When you listen to a mono signal on two speakers, you hear a false or 'phantom' image which is derived midway between the speakers, but because both speakers are contributing to the sound, the level of the bass seems to be over-inflated. To truly hear a monogised signal via one speaker (the way everyone else will hear it) the mono switch should be active but also either Left Cut or Right Cut should also be activated (depending on preference/location) to derive the signal from a single location.

Listen to the 'Stereo difference' or side signal

A very useful facility of the MC2.1 is the ability to listen to the 'stereo difference' or side signal, very quickly and easily. The side signal is the difference between the two channels, and describes those elements that contribute to the stereo width.

Hearing the stereo difference is so simple using the MC2.1: with the stereo signal playing, activate the **Phase Reverse** switch, and then sum the left and right channels using the **Mono** switch (in other words Left-Right). It's that simple.

Being able to audition the 'side' signal is particularly useful for judging the quality and quantity of any ambience or reverberation in a stereo mix. It is also an invaluable facility if the stereo recording has timing differences between channels (such as caused by an azimuth error on a tape machine), or for aligning a pair of desk channels for use with X-Y stereo mic pairs. In both cases, listening for a deep cancellation null, as the two signals cancel each other out, is a very fast and accurate way of matching levels in each channel, which is the basis of accurate alignment.

MC2.1 GENERAL INFORMATION**IF A FAULT DEVELOPS**

For warranty service please call Drawmer Electronics Ltd. or their nearest authorised service facility, giving full details of the difficulty. A list of all main dealers can be found on the Drawmer webpages. On receipt of this information, service or shipping instructions will be forwarded to you.

No equipment should be returned under the warranty without prior consent from Drawmer or their authorised representative.

For service claims under the warranty agreement a service Returns Authorisation (RA) number will be issued. Write this RA number in large letters in a prominent position on the shipping box. Enclose your name, address, telephone number, copy of the original sales invoice and a detailed description of the problem.

Authorised returns should be prepaid and must be insured.

All Drawmer products are packaged in specially designed containers for protection. If the unit is to be returned, the original container must be used. If this container is not available, then the equipment should be packaged in substantial shock-proof material, capable of withstanding the handling for the transit.

CONTACTING DRAWMER

We will be pleased to answer all application questions to enhance your usage of Drawmer equipment.

Please address correspondence to:

DRAWMER Electronics LTD
Coleman Street
Parkgate
Rotherham
South Yorkshire
S62 6EL
United Kingdom

Telephone: **+44 (0) 1709 527574**
Fax: **+44 (0) 1709 526871**

Contact via E-mail: **tech@drawmer.com**

Further information on all Drawmer products, dealers, Authorised service departments and other contact information can be found on our website: **www.drawmer.com**

SPECIFICATION

Note: These specifications are provisional and may alter slightly upon product release.

INPUT

Maximum Input Level 21dBu

OUTPUT

Maximum Output Level
before clipping 27dBu

DYNAMIC RANGE

@ unity gain 118dB

CROSSTALK

L/R @ 1kHz >85dB
Adjacent Input >95dB

THD & NOISE

unity gain 0dBu input
0,0014%

FREQUENCY RESPONSE

20Hz-20kHz +/- 0.2dB

PHASE RESPONSE

20Hz-20kHz +/- 2degrees max

POWER REQUIREMENTS

115V or 230V at 50-60Hz, 20VA
Voltage set by internal voltage switch

FUSE RATING

@ 115V T315mA
@ 230V T160mA
Conforming to IEC 127-2

FUSE TYPE

20mm x 5mm, Class 3 Slo-BlO,
250Volt working

CASE SIZE

Depth (with Controls
& Sockets) 272mm
Width 215mm
Height (with Feet) 81mm

WEIGHT

2.5kg

DRAWMER

BLOCK DIAGRAM

